

www.eshops.gr *phocos*

Phocos Any-Grid™ series

Pure Sine Wave Battery Inverter Charger with
MPPT Solar Charge Controller

PSW-B-3KW-230/24V

User and Installation Manual

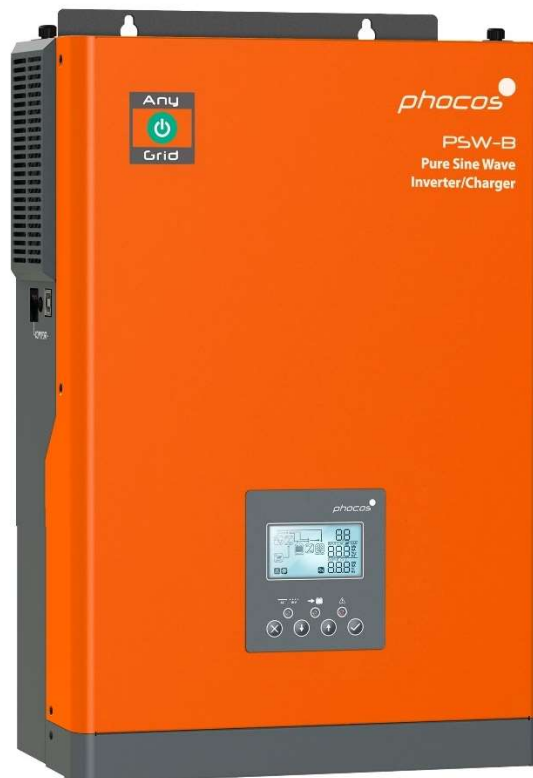

English

For further languages see
Für weitere Sprachen siehe
Pour autres langues voir
Para otros idiomas ver
对于其他语言请参阅

www.phocos.com

Contents

1.0	Introduction	2
2.0	Important Safety Information	2
3.0	Regulatory Information	3
4.0	Overview	4
4.1	Functional Overview	4
4.2	Product Overview	5
5.0	Installation	6
5.1	Package Contents	6
5.2	Mounting the Unit	6
5.3	Battery Connection	7
5.4	AC Input and AC Output Connection	8
5.5	PV Connection	9
5.6	Final Assembly	10
6.0	Operation	11
6.1	Inverter Power ON/OFF	11
6.2	Display and Control Module	12
6.3	Display Symbols	13
6.4	Device Operation Settings	14
6.5	Screen Views of Current Values	20
6.6	Operating Mode Description	23
7.0	Cleaning and Maintenance	25
7.1	Every Month	25
7.2	Every 6 Months	26
8.0	Fault Reference Codes	27
9.0	Warning Codes	28
10.0	Troubleshooting	29
11.0	Specifications	30
11.1	Grid Mode	30
11.2	Off-Grid Mode	31
11.3	Battery Charging	32
11.4	General	33
12.0	Warranty	34
12.1	Conditions	34
12.2	Liability Exclusion	34

1.0 Introduction

Dear customer, thank you for choosing this quality Phocos product. The Any-Grid™ PSW-B pure sine wave battery inverter / charger series has numerous outstanding features and use-cases such as:

- Function as purely Off-Grid inverter for applications with no AC power source
- Function as solar enabled (optional) uninterruptible power supply (UPS) functionality for intermittent or unstable AC sources
- Function as grid-connected or AC-generator-connected inverter to reduce energy demand from the AC source by prioritizing solar and / or battery power, thus saving energy costs
- Integrated MPPT solar charge controller means no external charge controller is required
- Battery charging from an AC source such as the public power grid or a genset
- Compatibility with multiple battery types including lead-acid (gel, AGM and liquid electrolyte) and lithium-based batteries such as LiFePO4 (as no battery management system communication is possible, ensure the battery can function without external communication before use)
- Both neutral (N) and live (L) wires of the AC input are automatically disconnected (break-before-make relays) from the AC output when the Any-Grid PSW-B operates in Off-Grid mode
- Grid feed-in is technically not possible as this device is not grid-interactive. It never operates in parallel to the AC source. It either uses the AC source to power loads directly from it (the inverter is not running at this time, the unit is acting purely as a load) in Grid mode. Or, in Off-Grid mode, the integrated inverter module is running, but isolated from the AC source on both neutral (N) and live (L) wires through air gaps.
- All-in-one unit allows simple and fast installation, and easy configuration
- Optional accessory: Phocos Any-Bridge™ IoT Gateway (sold separately) to connect to the PhocosLink Cloud from anywhere with any internet-capable device via its web browser

This manual describes the assembly, installation, operation, maintenance and troubleshooting of this unit.

2.0 Important Safety Information

SAVE THESE INSTRUCTIONS: This manual contains important instructions for model PSW-B-3KW-230/24V that shall be followed during installation and maintenance of the unit. Read and save this manual for future reference.

WARNING: The installation of this unit may only be undertaken by qualified personnel with appropriate training. High voltages in and around the unit can cause serious injury or death. This unit must be installed in accordance with rules and regulations at the site of installation.

CAUTION: A battery can present a risk of electrical shock, burning from high short-circuit current, fire or explosion from vented gasses. Observe proper precautions.

WARNING: This unit must be connected to a permanent grounded wiring system. Be sure to comply with local requirements and regulations when installing this unit.

BATTERY TYPE: Suitable for use with lead-acid (gel, AGM and liquid electrolyte) and lithium-based batteries such as LiFePO4.

OVERCURRENT PROTECTION FOR BATTERY: Install an overcurrent protection device with a minimum of 1000A interrupt rating as close as possible to the battery terminal. Select a device rated for 1.25 times the nominal current rating of the inverter / charger . An overcurrent protection device must be purchased separately.

1. Before using the unit, read all instructions and cautionary markings on this unit, the batteries, the solar modules, any connected loads.
2. Please do not disassemble or attempt to repair Phocos products. This unit does not contain user serviceable parts. Damage to the warranty seal will lead to a loss of warranty of the product and can lead to injury.
3. To reduce risk of electric shock, disconnect all wirings before attempting any maintenance or cleaning. Switching off the unit is not sufficient, turn off and / or disconnect all connections to the unit.
4. For safe operation of this unit, please adhere to appropriate cable size requirements in this manual.

5. Usage of insulated tools around the unit is strongly recommended. Be very cautious when working with uninsulated metal tools on or around batteries. They can short-circuit batteries or other electrical parts and could cause an explosion and / or injury.
6. Strictly follow the installation procedure when connecting or disconnecting AC or DC terminals. Please refer to the “**Installation**” section of this manual for details.
7. Appropriate fuses or breakers are required near the battery supply and AC input and AC output of this unit.
8. **WARNING:** It is highly recommended and legally required in many countries to install a Type B residual current device (RCD) between the AC output of the unit(s) and the AC loads to protect humans from hazardous electric shock due to faulty AC wiring, faulty loads or a potential inverter fault.
Only in Off-Grid mode, the neutral (N) and ground (PE) of the AC output are automatically bridged inside the Any-Grid to ensure the RCD’s functioning if the AC installation is wired correctly as a TN-S or TN-C-S earthing system. In a TN-C-S installation the bridge between neutral (N) and ground (PE) must be between the public grid and AC input of the Any-Grid to ensure that there is never more than one bridge between N and PE.
This unit is not designed to be operated in environments where an RCD is present between this unit and the AC source.
9. Never allow any AC or DC connections to be short-circuited. Do not connect to the mains when the battery input is short-circuited.
10. Only qualified service persons may service this device. If errors persist after following the “**Troubleshooting**” section in this manual, please send this unit back to a local Phocos dealer or service center for maintenance.
11. **WARNING:** Only solar panels are acceptable for use which do not require positive grounding as only grounding of the negative PV cables is allowed, if necessary. Grounding of the PV module frame is permitted and frequently required by local law. The MPPT solar charge controller is not galvanically isolated from the battery, but is isolated from the inverter.
The battery is galvanically isolated from the inverter, therefore the battery positive or negative terminal may be grounded if required.
12. **CAUTION:** It is highly recommended to use a surge arrester, also named surge protective device (SPD) near the PV input terminals of this unit. This is to prevent damage to the unit from lightning, thunderstorms or other voltage surges on the PV cables. The max. DC operating voltage of the SPD must be between 145 and 160 Vdc. For example the *Citel DS240-110DC* is suitable.
13. **CAUTION:** It is highly recommended to use a surge arrester, also named surge protective device (SPD) near the AC input terminals of this unit, if the AC input is used. This is to prevent damage to the unit from lightning, thunderstorms or other voltage surges on the AC input conductors (for example coming from the public grid). The max. AC operating voltage of the SPD must be between 275 and 300 Vac for 230 Vac models. For example, the *Citel DS41S-230* (for most public grids or generators, higher protection) or *Citel DS41S-320* (for public grids with large voltage swings, lower protection) are suitable.
When using with a 110 ~ 127 Vac AC source the SPD must have a max. AC operating voltage between 140 and 150 Vac. For example, the *Citel DS41S-120* is suitable.

3.0 Regulatory Information

This product is CE and RoHS (Restriction of Hazardous Substances) compliant.

Please find the CE declaration at www.phocos.com.



This product is manufactured in an ISO 9001 (quality management) and ISO 14001 (environmental management) certified facility.

This equipment is suitable for use in non-hazardous locations only.

This is a class A device: in a domestic environment this product may cause radio interference in which case the user may be required to take adequate measures.

4.0 Overview

4.1 Functional Overview

This pure sine wave battery inverter charger with solar charge controller (MPPT) can provide power to connected loads by utilizing PV power, AC power and battery power. Most connections are optional, but there must be at least one power source (AC or PV) and battery connected:

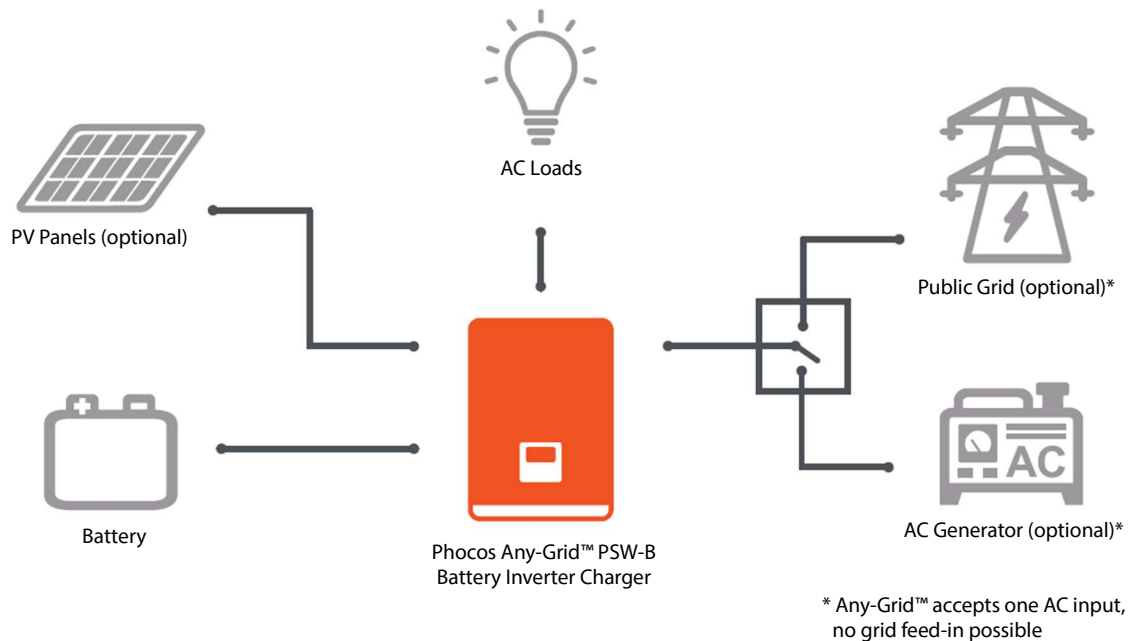

Fig. 1: System Overview

This unit has one each of the following power connections: battery, PV, AC input, AC output. The unit is designed to provide continuous power from PV / battery or an AC source, depending on the set priority. Independently, the priority for charging the battery can be set (the battery can only be charged from AC when the unit is not working in Off-Grid mode). The switching time between Grid (also valid when an AC generator is used) and Off-Grid modes is only 10 milliseconds (typical).

In Grid mode the unit can pass AC power from the AC source to AC loads. PV power is only charged into the battery in this mode. In Off-Grid mode the AC loads are supplied by PV power and if not sufficient, also by the battery via the inverter. It is not possible to power AC loads with PV power and power for the AC source at the same time, only to switch back and forth between these sources.

The pure sine wave AC output and the surge power capability (twice the continuous power rating) assure all types of AC loads can be powered. Ensure that the peak power requirement of the loads is below the surge power capability of this inverter.

4.2 Product Overview

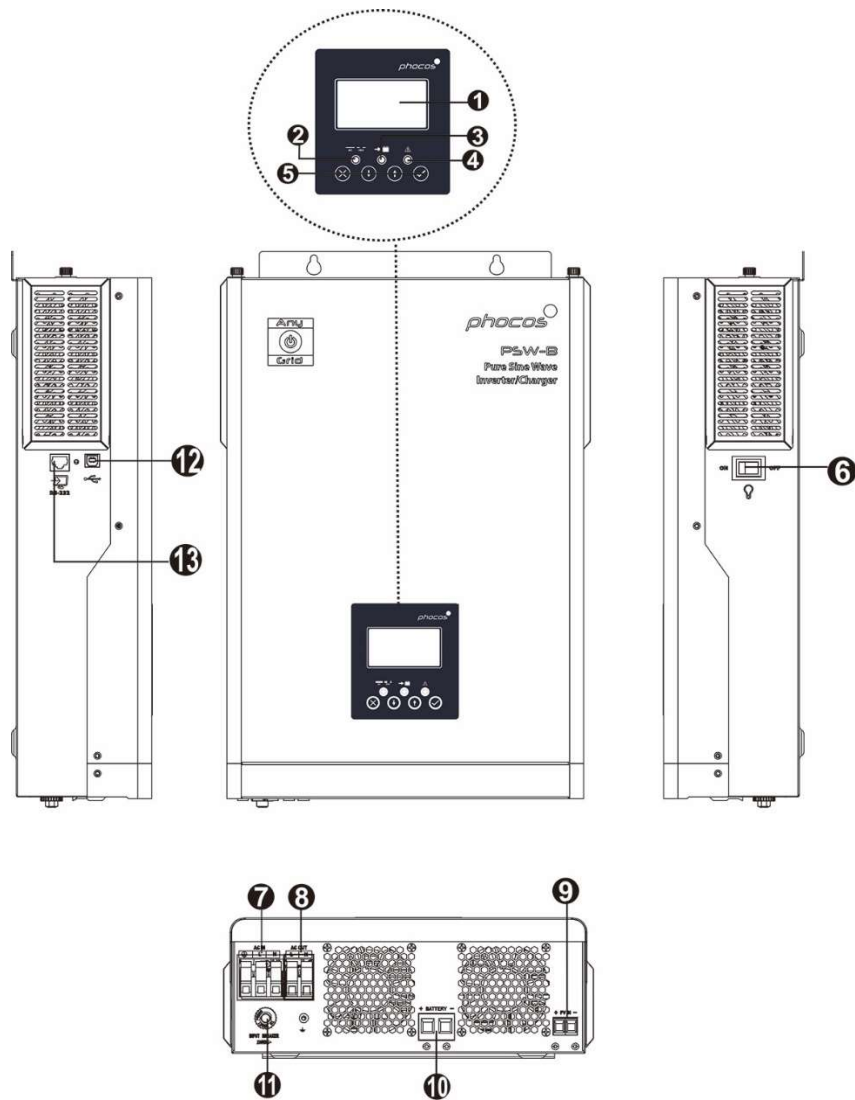

Fig. 2: Product Overview

1. LCD screen
2. Inverter status indicator
3. Charging indicator
4. Fault indicator
5. Function buttons
6. AC output on/off switch (solar charging still functions when the AC output is powered off)
7. AC input terminals (public grid or AC generator connection)
8. AC output terminals (load connection)
9. PV terminals
10. Battery terminals
11. Resettable circuit breaker
12. USB communication port
13. RS-232 communication port

CAUTION: Using any other cable or interface than the one provided for RS-232 on RS-232 communication port 13 (such as an Ethernet device), or a device explicitly compatible with the PSW-B, is likely to damage the Any-Grid PSW-B and / or the connected device. Such damage is not covered under warranty.

5.0 Installation

5.1 Package Contents

Before installation, please inspect the unit to ensure nothing inside the package is damaged. Package contents:

- Any-Grid PSW-B unit
- This manual
- RS-232 cable (SUB-D to RJ-45)
- Strain relief for battery cables with two screws
- Strain relief for solar / PV cables with two screws
- Two cable ties for use with strain reliefs

5.2 Mounting the Unit

Before connecting all wirings, please take off the bottom cover by removing two screws as shown below and carefully sliding the cover down. (**Fig. 3**).

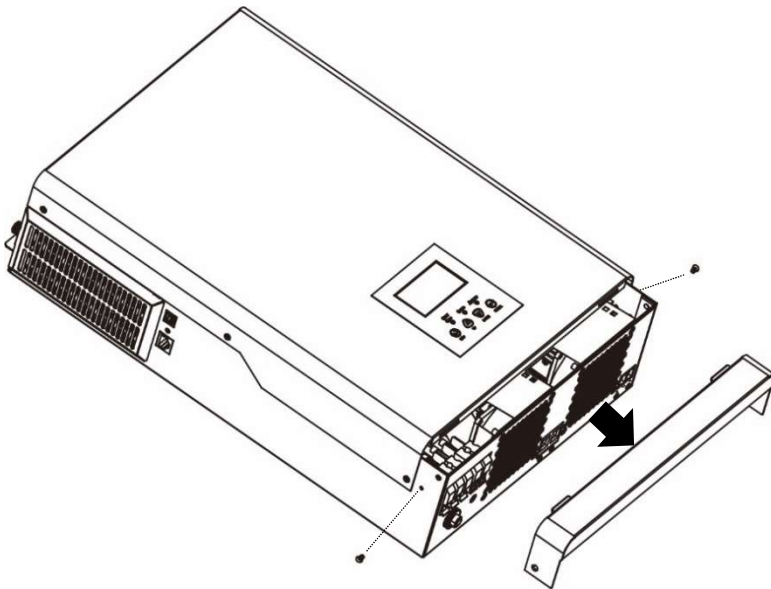

Fig. 3: Removal of bottom cover

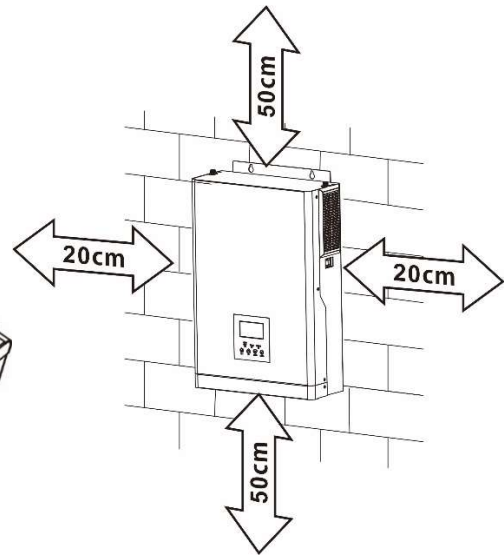

Fig. 4: Minimum distance to other objects

WARNING: Only mount this unit on concrete or another solid non-combustible surface capable of securely holding the weight of the unit.

- Install this inverter at eye level to ensure legibility of the display
- Ensure the ambient temperature is between $-10 \sim 50 \text{ }^{\circ}\text{C}$, $14 \sim 122 \text{ }^{\circ}\text{F}$ at all times
- Avoid excessively dusty environments
- The unit is designed for vertical installation on a solid wall
- Ensure a minimum distance to other objects and surfaces as shown in **Fig. 4** to guarantee sufficient heat dissipation and to have enough space for removing wires.
- Install in a room where noise is not an issue as the unit has fans for cooling

Install the unit by using two M4 or M5 screws (**Fig. 5**) appropriate for the weight of the unit and wall material, use wall plugs. This bottom cover must remain removed for the rest of this “**Installation**” chapter until instructed otherwise.

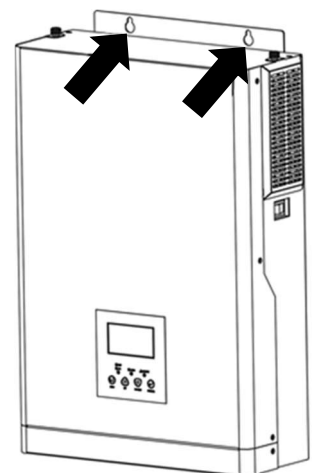

Fig. 5: Mounting holes

5.3 Battery Connection

WARNING: The installation of this unit may only be undertaken by qualified personnel with appropriate training. High voltages in and around the battery and unit can cause serious injury or death. This unit must be installed in accordance with rules and regulations at the site of installation.

WARNING: Choose a suitable battery fuse as outlined in the chapter “Important Safety Information”, section “OVERCURRENT PROTECTION FOR BATTERY”.

WARNING: Ensure the battery cables are sized according to the table below. Inadequate battery cables can cause excessive heat or fire during operation.

Recommended battery cable cross-section, battery size and fuse / DC circuit breaker rating:

Battery cable cross-section	35 mm ² , AWG 2
Min. battery capacity (lead-based)	200 Ah
Battery discharge current capability	167 Adc cont., 334 Adc surge (5s)
Fuse / breaker rating	210 Adc, min. 33 Vdc

Steps to connect the battery:

1. **WARNING: Ensure the battery cables are not yet connected to the battery and that the battery fuse is removed or battery circuit breaker is open.**
CAUTION: Ensure none of the cable insulation is jammed into the terminal.
 Remove 18 mm / 0.7 in of insulation from the ends of the battery conductors to be installed on the inverter unit.
2. It is recommended to securely crimp ferrules onto these exposed cable ends if using stranded wires.
3. Fasten the strain relief plate under the battery terminals marked “+ BATTERY -” with the two included screws:

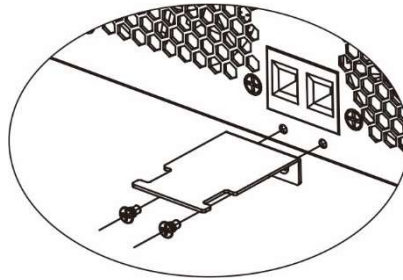

Fig. 6: Battery cable strain relief installation

4. Connect the other end of the battery conductors to the battery. Ensure the polarity of the battery terminals on the Any-Grid match the battery polarity.
5. Now insert the inverter-side wires of the battery into the inverter battery terminals, ensuring correct polarity. Tighten the inverter battery terminals with a torque of 2 Nm (1.5 lbf·ft).
CAUTION: Reverse polarity connection to the battery may damage the unit.
CAUTION: Over-tightening the terminal nuts can cause damage to the terminal, under-tightening can cause a loose connection and excessive heat during operation, make sure to use the prescribed torque.

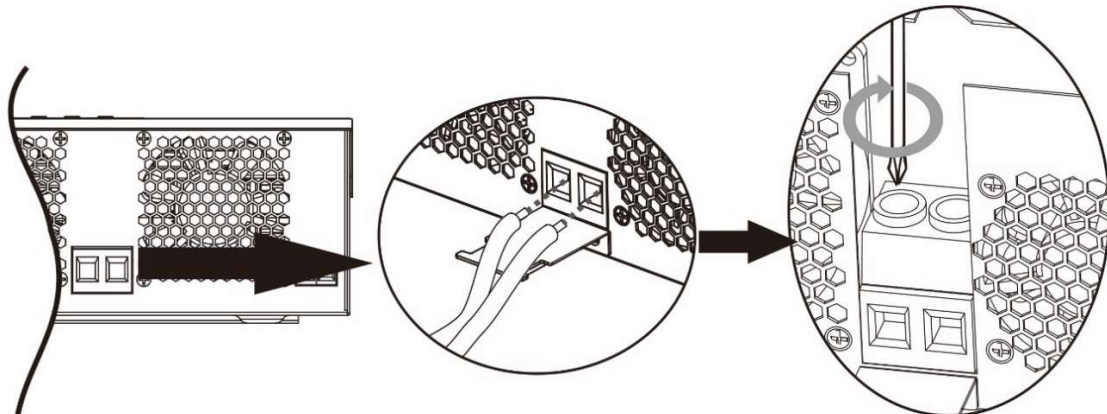

Fig. 7: Battery connection

6. Fix the conductors to the strain relief with an included cable tie:

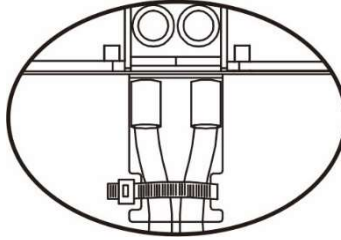

Fig. 8: Battery cable strain relief

5.4 AC Input and AC Output Connection

WARNING: Before connecting an AC source to the AC input of the Any-Grid, install an AC circuit breaker between the Any-Grid and AC input power source. This will ensure the inverter can be securely disconnected during maintenance and fully protected from over current of AC input. Make sure the breaker is open / off for the rest of the installation procedure until instructed otherwise.

WARNING: Ensure that the installation has adequate grounding and connect the protective earth (PE) terminals to this ground as instructed below. Failure to do so can cause serious injury or death once the unit is powered up or the AC source is activated via its breaker.

WARNING: Ensure the AC cables are sized according to the table below. Inadequate AC cables can cause excessive heat or fire during operation.

CAUTION: Do not connect an AC source to the “AC OUT” labelled terminal of the unit as this will destroy the unit. Only connect it to the “AC IN” labeled terminal.

CAUTION: Only AC sources with a neutral may be used connected. Using AC sources with two phases on an Any-Grid PSW-B instead, will cause damage.

Recommended AC cable cross-section and AC circuit breaker rating:

AC input and output cable cross-section	4 ~ 10 mm ² , AWG 7 ~ AWG 11
Circuit breaker rating	30 Aac, ≥ 280 Vac if operated with 220 ~ 240 Vac source or ≥ 140 Vac if operated with 110 ~ 127 Vac source

Steps to connect the AC source and AC loads:

1. **WARNING: Ensure the battery cable fuse is removed or breaker is secured in the open position. WARNING: Ensure the AC source breaker is secured in the open position and there is no voltage on the conductors before continuing.**
2. Remove 10 mm / 0.4 in of insulation for the six AC conductors (neutral “N”, live “L” and protective earth “PE” for the AC source and loads).
3. It is recommended to securely crimp ferrules onto these exposed cable ends if using stranded wires.
4. Insert the “PE” protective conductor (⊕) from the AC source first into the corresponding AC input terminal and tighten with a torque of 1.2 Nm (0.9 lbf-ft). Repeat for the neutral “N” and live “L” conductors of the AC source.

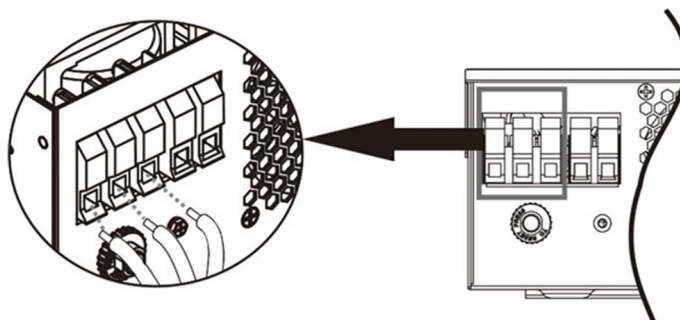



Fig. 9: AC Input connection

- Attach the “PE” protective conductor  of the AC output wiring to the grounding screw with an appropriate ring terminal as shown below. Insert the neutral “N” and live “L” conductors of the AC loads into the corresponding two terminals marked “AC OUT” and tighten with a torque of 1.2 Nm (0.9 lbf-ft).

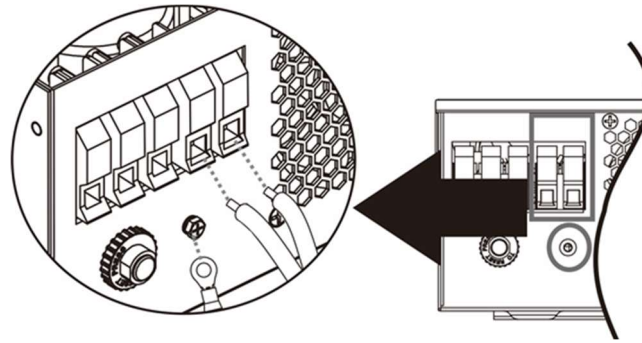

Fig. 10: AC Output connection

- Make sure the six wires are securely connected.
CAUTION: Over-tightening the terminal screws can cause damage to the terminal, under-tightening can cause a loose connection and excessive heat during operation, make sure to use the prescribed torque where defined. Ensure none of the conductor insulation is jammed between the terminal contacts.
CAUTION: Ensure the polarity is correct on all wires. Failure to do so may cause damage.

5.5 PV Connection

WARNING: Before connecting the PV module array to the PV input of the Any-Grid, install a DC circuit breaker between each Any-Grid PV terminal pair and the PV modules. This ensures the inverter can be securely disconnected during maintenance and is protected from over-current of the PV modules. PV modules produce a dangerous voltage even at low light. Make sure the breaker is open / off for the rest of the installation procedure until instructed otherwise.

WARNING: Ensure the PV cables are sized according to the table below. Inadequate PV cables can cause excessive heat or fire during operation.

Recommended PV cable cross-section and DC circuit breaker rating:

PV cable cross-section	6 ~ 16 mm ² , AWG 5 ~ AWG 10
Circuit breaker rating	60 Adc, min. 150 Vdc

For selecting the correct PV module configuration, please consider the following points:

- The total open circuit voltage (Uoc / Voc) of the PV module array may never exceed the values in the table below. Consider the coldest possible temperatures at the installation location together with the temperature coefficient of the PV modules used.
- The total maximum power point voltage (Umpp / Vmpp) of the PV module array must be above the minimum values in the table below. Consider the hottest PV module temperatures at installation location.
- The total maximum power point current (Impp / Ampp) of the PV array may not exceed the values below.
- The total PV array power may not exceed the corresponding value in the table below.

Max. PV voltage (Uoc)	145 Vdc
Min. PV mpp voltage (Umpp)	30 Vdc
Max. mpp current (Impp)	60 Adc
Max. PV array power	2250 Wp

Steps to connect the PV module array:

1. Remove 10 mm / 0.4 in of insulation from the positive and negative PV cables.
2. It is recommended to securely crimp ferrules onto these exposed cable ends if using stranded wires.
3. Fasten the strain relief plate under the PV terminals marked "+ PV IN -" with the two included screws:

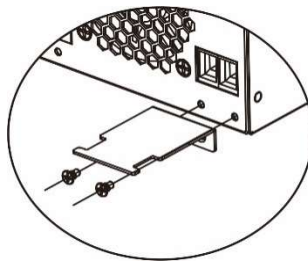

Fig. 11: PV cable strain relief installation

4. Insert the positive PV cable into the PV input "+" terminal and the negative PV cable into the PV input "-" terminal.

CAUTION: Ensure correct polarity.

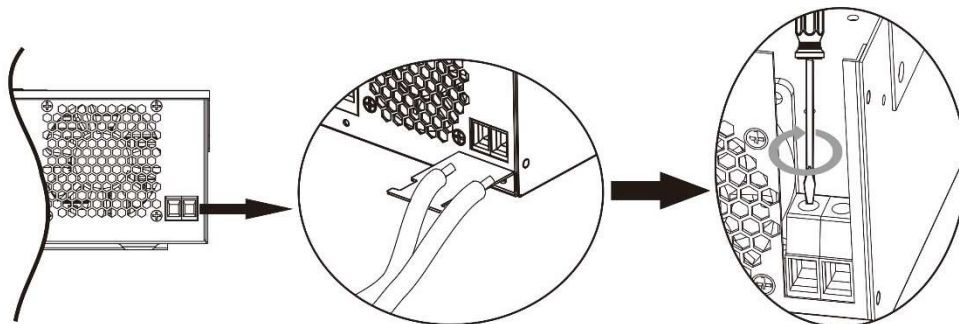

Fig. 12: PV connection

5. Tighten both terminal screws with a torque of 1.6 Nm (1.2 lbf-ft) and make sure the two wires are securely connected.

CAUTION: Over-tightening the terminal screws can cause damage to the terminal, under-tightening can cause a loose connection and excessive heat during operation, make sure to use the prescribed torque. Ensure none of the cable insulation is jammed between the terminal contacts.

6. Fix the conductors to the strain relief with an included cable tie:

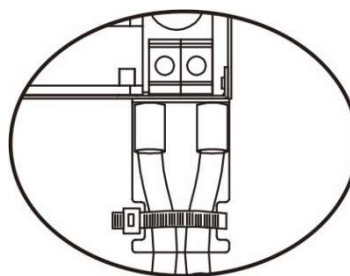

Fig. 13: PV cable strain relief

5.6 Final Assembly

After Battery, PV and AC wiring is completed, please slide the bottom cover back up on the unit and secure it by fastening the two screws as shown below.

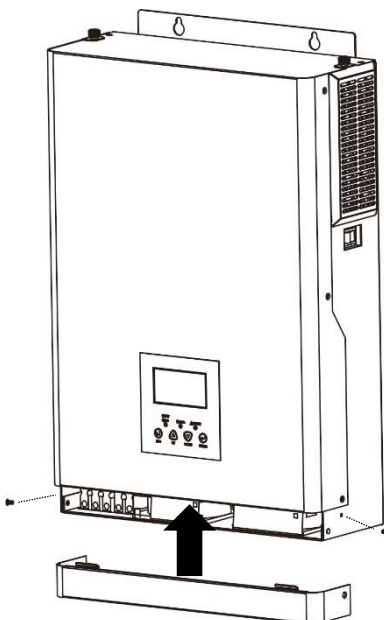

Fig. 14: Re-applying bottom cover

6.0 Operation

6.1 Inverter Power ON/OFF

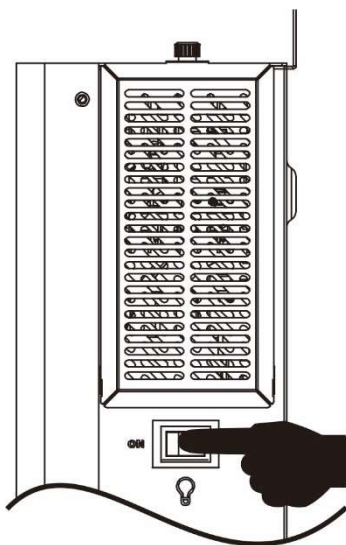

Fig. 15: Load output ON/OFF button location

Ensure the "ON/OFF" switch located on the right side of the unit (**Fig. 15**) is in the "OFF" position after the initial installation.

Now activate the circuit breakers or insert the fuses to energize the various inputs and outputs in the following order (skip any that are not connected):

1. Battery
2. AC input
3. PV input
4. AC output

Next, switch the "ON/OFF" (**Fig. 15**) button to the "ON" position to turn on the AC output and thus connected AC loads and the entire unit.

If the "ON/OFF" switch is in the "OFF" position, then the unit will be completely off when there is insufficient sunlight.

If PV modules are connected and there is sufficient PV voltage, the unit and display will wake up automatically to charge the batteries during the day. Once the PV voltage drops below the min. PV voltage threshold, the unit will again turn completely off to save energy during the night. The AC output and thus the AC loads will remain off as long as the "ON/OFF" switch is in the "OFF" position.

6.2 Display and Control Module

The display and control module, shown in **Fig. 16**, includes three LED indicators, four function buttons, and a LCD-screen, indicating the operating status and allowing the programming of settings parameters.

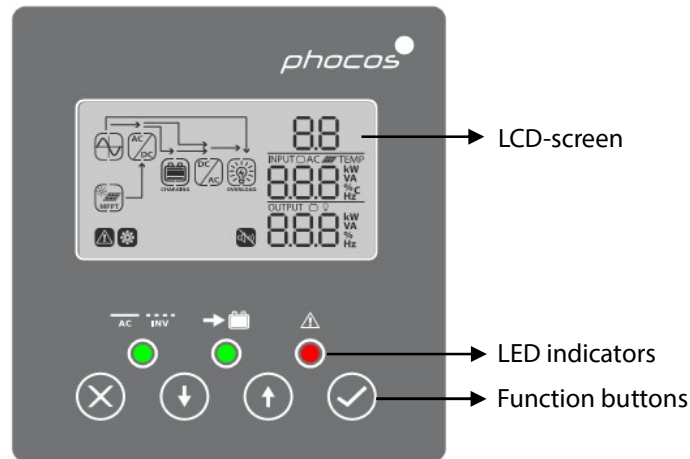









Fig. 16: Display module buttons and indicators

Indicator Description

Indicator	Colour	Solid On / Flashing	Description
	Green	Solid On	AC output powered by AC input (Grid mode)
		Flashing	AC output powered by integrated inverter (Off-Grid mode)
	Green	Solid On	Battery is fully charged
		Flashing	Battery is charging
	Red	Solid On	Fault mode
		Flashing	Warning mode

Function Buttons

Function Button	Description
	Escape / close Exit settings without confirming
	Up To last selection
	Down To next selection
	Enter To confirm/enter the selection in setting mode

6.3 Display Symbols

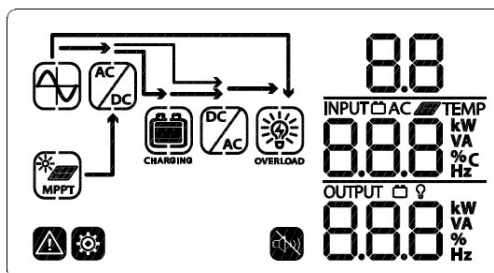















Fig. 17: LCD-Screen symbols

Symbol	Description	
Input Information		
	Indicates AC input	
	Indicates PV input	
	Indicates input voltage, input frequency, PV voltage, PV current, PV power, charging current, charging power, battery voltage.	
Settings menu and Fault Information		
	Indicates the setting menus	
	Indicates warning and fault codes. Warning: flashing with warning code and flashing red LED. Fault: shown with fault code and solid red LED.	
Output Information		
	Indicates output voltage, output frequency, load in % of nominal power, load in VA, load in Watt and discharging current.	
Battery Information		
	Indicates battery level in 0 ~ 24%, 25 ~ 49%, 50 ~ 74% and 75 ~ 100% (left to right) increments in Off-Grid mode and charging status in Grid mode.	
In Grid mode, the battery indicator shows the following:		
Status	Battery Voltage	LCD Display
All battery charging modes except Floating phase	< 24 V	4 bars flash in turns
	24 ~ 25 V	Bottom bar constantly on and other three bars flash in turns
	25 ~ 26 V	Bottom two bars constantly on and other two bars flash in turns
	> 26 V	Bottom three bars constantly on and top bar flashes

Floating phase. Batteries are fully charged.	4 bars constantly on	
In Off-grid mode, the battery indicator shows the following:		
Load Percentage	Battery Voltage	LC-Display
Load > 50%	< 22.2 V	0 ~ 24%
	22.2 ~ 23.2 V	25 ~ 49%
	23.2 ~ 24.2 V	50 ~ 74%
	> 24.2 V	75 ~ 100%
Load < 50%	22.7 V	0 ~ 24%
	22.7 ~ 23.7 V	25 ~ 49%
	23.7 ~ 24.7 V	50 ~ 74%
	> 24.7 V	75 ~ 100%
Load Information		
	Indicates overload	
	Indicates load level by 0 ~ 24%, 25 ~ 49%, 50 ~ 74% and 75 ~ 100% (left to right) increments.	
Mode Operation Information		
	Constantly on: AC source valid Blinking: AC source present but rejected	
	PV input valid	
	Load supplied by AC input	
	AC source charger circuit is active	
	DC to AC inverter circuit is active	
	Alarm disabled	

6.4 Device Operation Settings

General Settings

Press  for 3 seconds to enter settings mode. Press  or  to select between settings menus. Once selected, press  to confirm the selection or  to exit without confirmation.





Settings menus

Menu no.	Description	Selectable Option and Notes	
00	Exit setting mode	Escape 00 * ESC	
01	AC output source priority: Configure the priority of which power sources supply the AC output load	Solar first 01 * SOL	<p>Solar provides power to the loads as first priority. If solar power is not sufficient to power all connected loads, battery power will supply the loads simultaneously (Off-Grid mode).</p> <p>If no solar power is available (ex. at night), or the battery voltage reaches the setting point in settings menu 12, AC input / utility power is used exclusively. During this time any PV power available is used to charge the battery. With unavailable solar power the battery is only discharged (apart from unit self-consumption) when the AC input / utility power is unavailable (Off-Grid mode).</p>
		Utility / AC input first (Default) 01 * UTI	<p>AC input / utility will provide power to the loads as first priority (Grid mode).</p> <p>Solar and battery will provide power to the loads only when utility power is not available (Off-Grid mode).</p>
		SBU priority "SBU" for: Solar → Battery → Utility 01 * SBU	<p>Solar powers the loads as first priority. If solar power is not sufficient to power all connected loads, the battery will supply power to the loads simultaneously. The Any-Grid is disconnected from the grid at this time (Off-Grid mode).</p> <p>AC input / utility provides power to the loads (Grid mode) only when the battery voltage drops to either low-level warning voltage or the setting point in settings menu 12. In this case the loads are powered only from the AC source. Any PV power is used to charge the battery while in Grid mode.</p>

02	Maximum total battery charging current of AC and solar charging combined:	10A 02	60A (Default) 02
	Max. total charging current = AC input charging current + solar charging current This setting is important to limit charging current for some battery types.	* 10 ^A	* 60 ^A
		Can be set from 10 ~ 120 Adc in 10 Adc increments. This is the battery-side DC charging current.	
03	AC input voltage range	Appliances 03	Accepted AC input voltage range from 90 ~ 280 Vac if settings menu 10 is set from 220 ~ 240 Vac. 80 ~ 140 Vac if settings menu 10 is set from 110 ~ 127 Vac
	In addition to wider voltage tolerance, "Appliances" setting also allows more deformed sine-waves to be accepted at the AC input compared to "UPS" mode.	* APL	
		UPS (Default) 03	Accepted AC input voltage range from 170 ~ 280 Vac if settings menu 10 is set from 220 ~ 240 Vac. 90 ~ 140 Vac if settings menu 10 is set from 110 ~ 127 Vac
		* UPS	
05	Battery type	AGM (Default) 05	Flooded 05
	Settings menus 26, 27 and 29 can only be modified if "User-defined" is selected here	* AGM	* FLd
		User-defined 05	Battery charging voltages and low voltage disconnect (LVD) can be manually defined in settings menu 26, 27 and 29.
		* USE	
06	Automatic restart if an AC output overload occurs	Restart disabled (Default) 06	Restart enabled 06
		* LFD	* LFE
07	Automatic restart when over-temperature occurs	Restart disabled (Default) 07	Restart enabled 07
		* OTD	* OTE
09	AC output frequency	50 Hz (Default) 09	60 Hz 09
	Only relevant for Off-Grid mode	* 50 ^{Hz}	* 60 ^{Hz}

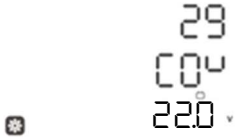
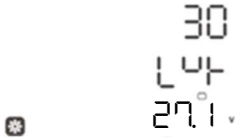
10	<p>AC output voltage</p> <p>Defines AC output voltage in Off-Grid mode and AC input voltage limits (see settings menu 03). Any modification between 110/120/127 Vac and 220/230/240 Vac will be effective only after the inverter is restarted.</p>	<p>230 Vac (Default)</p> <p>10 230</p>	<p>Available values: 110, 120, 127, 220, 230 and 240 Vac.</p>
11	<p>Maximum AC source charging current (battery side)</p> <p>If settings menu 02 is smaller than this value, charging will be limited by the value in settings menu 02.</p>	<p>30 Adc (Default)</p> <p>11 061 30</p>	<p>Available values: 2 Adc and 10 ~ 60 Adc in 10 Adc increments.</p>
12	<p>Voltage set-point to switch from Off-Grid mode to Grid mode when "SBU priority" or "Solar first" is selected in settings menu 01.</p>	<p>24 Vdc (Default)</p> <p>12 240</p>	<p>Available values: 22.0 ~ 28.5 Vdc in 0.5 Vdc increments.</p>
13	<p>Voltage set-point to switch from Grid mode to Off-Grid mode when selecting "SBU priority" or "Solar first" in settings menu 01.</p>	<p>Battery fully charged</p> <p>13 FUL</p>	<p>27 Vdc (Default)</p> <p>13 270</p> <p>Available values: "FULL" and 24.0 ~ 31.5 in 0.5 Vdc increments.</p> <p>The battery is considered fully charged when the float charging phase is reached.</p>
16	<p>Battery charger source priority</p> <p>Configure the priority of which power sources are used to charge the battery. The AC source can only charge the battery if in Grid, Stand-By or Fault modes. In Off-Grid mode only solar / PV power can charge the battery.</p> <p>It is recommended not to choose "Only Solar" if an AC source is available because the self-consumption of the Any-Grid unit is supplied from the battery. If there are long periods without sunshine (ex. snow), the unit may shut down due to low battery voltage. Instead, select "Solar first" here and 2 Adc in settings menu 11 to compensate for the self-consumption with some safety margin.</p>	<p>Solar first</p> <p>16 C50</p>	<p>Solar power will charge battery as first priority.</p> <p>Utility / AC source will charge battery only when solar energy is not available and the unit is in Grid mode.</p>
		<p>Utility first</p> <p>16 CUT</p>	<p>Utility / AC source will charge battery as first priority.</p> <p>Solar power will charge battery only when no AC source is available.</p>
		<p>Solar and Utility (Default)</p> <p>16 SNU</p>	<p>Solar power and AC input power will charge battery at the same time if the unit is in Grid mode.</p>
		<p>Only Solar</p> <p>16 050</p>	<p>Solar power will be the only battery charging source, regardless of the operating mode.</p>

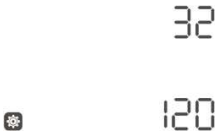
18	General alarm control	Alarm on (Default) 18 * 607	Alarm off 18 * 60F
19	Automatic return to default overview display screen	Return to default display view (Default) 19 * ESP	The display will return to the default overview (input voltage / output voltage) if no button is pressed for approx. 1 minute.
		Remain at last view 19 * 1EP	The display will remain at the selected view indefinitely, until another view is selected.
20	Display backlight control	Backlight always on (Default) 20 * LON	Backlight off after one minute of no button presses 20 * LOF
22	Beeps while primary source is interrupted	Alarm on (Default) 22 * AON	Alarm off 22 * AOF
23	Overload by-pass: When enabled, the unit will quickly switch to Grid mode if an AC output overload occurs in Off-Grid mode. It will return back to Off-Grid mode once the load power has normalized (min. timeout 10 minutes).	By-pass disabled (Default) 23 * byd	By-pass enabled 23 * byE
26	Boost battery charging voltage	28.8 Vdc (Default) 26 * 288	If "User-defined" is selected in settings menu 05, this value can be changed. Available values: 25.0 ~ 31.5 Vdc in 0.1 Vdc increments.
27	Floating battery charging voltage	27.6 Vdc (Default) 27 * 276	If "User-defined" is selected in settings menu 05, this value can be changed. Available values: 25.0 ~ 31.5 Vdc in 0.1 Vdc increments.

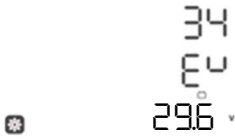
29	<p>Low voltage disconnect</p> <p>The AC output is turned off when the battery reaches this voltage level to protect the battery from deep discharge. The low DC / battery warning voltage is 1 Vdc above this setting.</p> <p>This value must be set at least 2 Vdc lower than settings menu 30.</p>	<p>22.0 Vdc (Default)</p> 	<p>If "User-defined" is selected in settings menu 05, this value can be changed.</p> <p>Available values: 18.8 ~ 27.0 Vdc in 0.1 Vdc increments.</p> <p>This voltage is fixed and independent of the load power level.</p>
30	<p>Low voltage reconnect</p> <p>If the AC output is turned off due to low voltage disconnect (settings menu 29), the AC output is automatically turned back on once this voltage is reached. This value must be at most 0.5 Vdc below settings menu 27, and at least 2 Vdc higher than settings menu 29.</p>	<p>27.1 Vdc (Default)</p> 	<p>If "User-defined" is selected in settings menu 05, this value can be changed.</p> <p>Available values: 20.9 ~ 31.0 Vdc in 0.1 Vdc increments.</p>
32	<p>Boost battery charging duration</p> <p>The duration for which the boost voltage from settings menu 26 is held before the Floating phase is reached.</p>	<p>Automatic</p> 	<p>120 min (Default)</p>  <p>If "User-defined" is selected in settings menu 05, this value can be changed. Available values: "Automatic" and 5 ~ 900 minutes in 5 min. increments.</p> <p>If "Automatic" is set, the duration of bulk phase (see chapter "Specifications" → "Battery Charging") is multiplied by 10, with a minimum of 10 minutes and maximum of 8 hours.</p>
33	<p>Battery equalization</p> <p>Battery equalization helps prevent sulfation of lead-acid batteries and is beneficial for bringing all cells to the same voltage. Consult your battery manual to make sure the battery can withstand the higher voltages required for this purpose. This is typically the case for flooded lead-acid batteries.</p>	<p>Enabled</p> 	<p>Disabled (Default)</p>  <p>If "User-defined" or "Flooded" is selected in settings menu 05, this value can be changed.</p>
34	<p>Battery equalization voltage</p>	<p>29.6 Vdc (Default)</p> 	<p>Available values: 25.0 ~ 31.5 Vdc increments.</p>

35	Battery equalization duration The duration for which the equalization voltage from settings menu 34 is held before the Floating phase is reached.	120 min. (Default) 35 120	Available values: 5 ~ 900 minutes in 5 min. increments.
36	Battery equalization timeout If the equalization voltage from settings menu 34 cannot be reached within the duration from settings menu 35, once this timeout is reached, equalization is ended and the charger returns to Floating phase.	180 min. (Default) 36 180	Available values: 5 ~ 900 minutes in 5 min. increments.
37	Equalization interval	30 days (Default) 37 30d	Available values: 0 ~ 90 days in 1-day increments.
39	Equalization phase: forced start	Enabled 39 AEN	Disabled (Default) 39 AdS
		<p>If the battery equalization function is enabled in settings menu 33, this function can be enabled. If "Enabled" is selected in this menu, battery equalization is immediately force-started and the display main view will show EQ (EQ).</p> <p>If "Disabled" is selected, it will cancel the forced equalization function until the next scheduled equalization interval as defined in settings menu 37. EQ will no longer be shown in LCD main page.</p>	

6.5 Screen Views of Current Values

The screen views can be scrolled by pressing \uparrow or \downarrow to show current values in the following order:

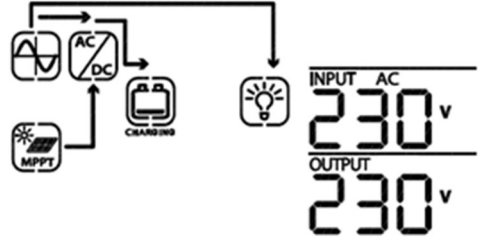
Measurement Values	Screen View Example
AC input voltage / AC output voltage (Default Display Screen)	Input voltage = 230 Vac, Output voltage = 230 Vac 

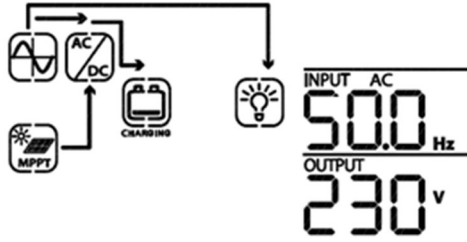
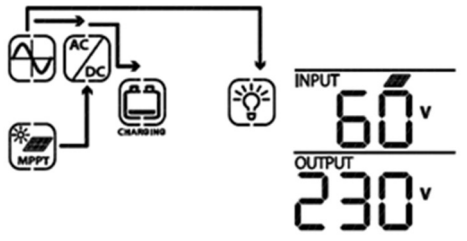
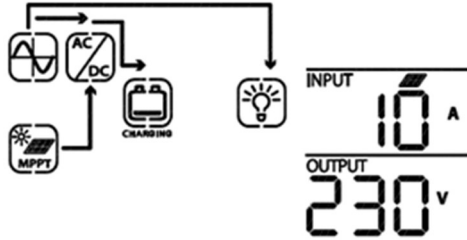
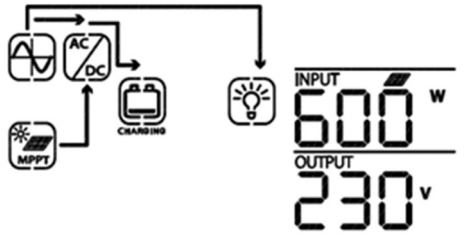
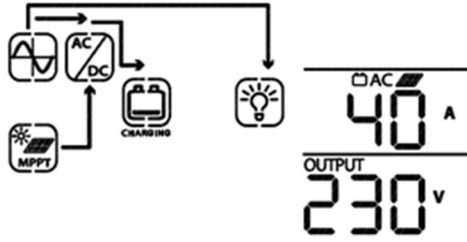
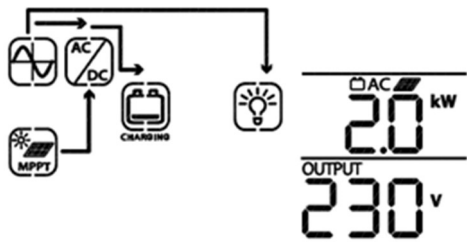

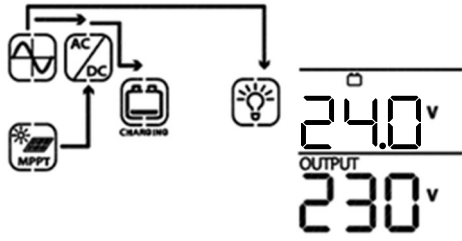
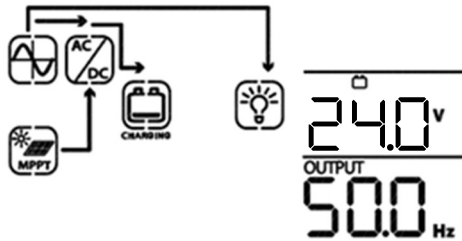
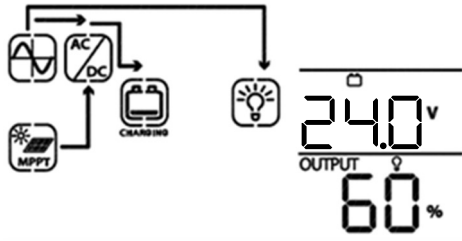
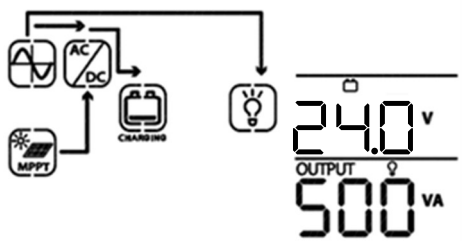
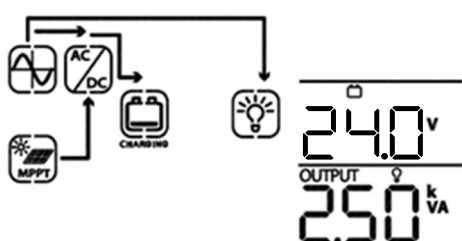

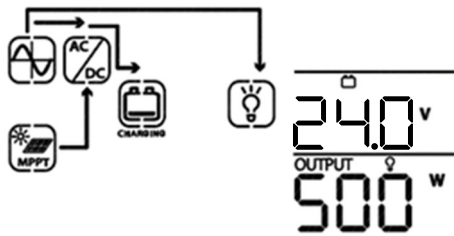
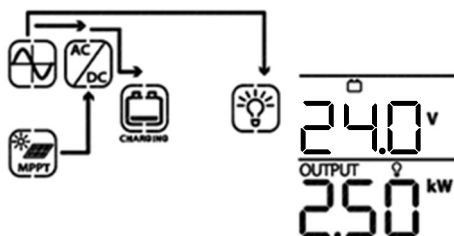
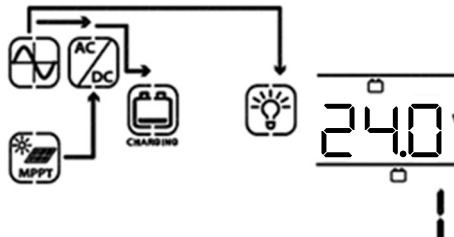
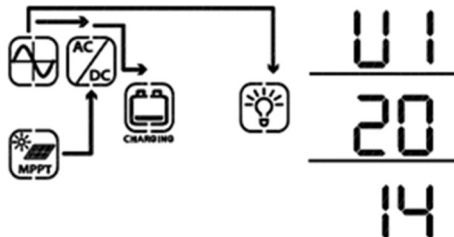
<p>AC input frequency</p>	<p>Input frequency = 50 Hz, Output voltage = 230 Vac</p>  <p>The diagram shows a power system with an MPPT solar panel, an AC/DC converter, a battery, and a light bulb. The digital display shows: INPUT AC 50.0 Hz, OUTPUT 230 V.</p>
<p>PV voltage</p>	<p>PV voltage = 60 Vdc</p>  <p>The diagram shows a power system with an MPPT solar panel, an AC/DC converter, a battery, and a light bulb. The digital display shows: INPUT 60 V, OUTPUT 230 V.</p>
<p>PV current (as measured on the battery side at battery voltage)</p>	<p>PV current = 10 Adc</p>  <p>The diagram shows a power system with an MPPT solar panel, an AC/DC converter, a battery, and a light bulb. The digital display shows: INPUT 10 A, OUTPUT 230 V.</p>
<p>PV power</p>	<p>PV power = 600 W</p>  <p>The diagram shows a power system with an MPPT solar panel, an AC/DC converter, a battery, and a light bulb. The digital display shows: INPUT 600 W, OUTPUT 230 V.</p>
<p>Charging current</p>	<p>AC and PV charging current (battery side) = 40 Adc</p>  <p>The diagram shows a power system with an MPPT solar panel, an AC/DC converter, a battery, and a light bulb. The digital display shows: INPUT AC 40 A, OUTPUT 230 V.</p>
<p>Charging power</p>	<p>AC and PV charging power = 2.0 kW</p>  <p>The diagram shows a power system with an MPPT solar panel, an AC/DC converter, a battery, and a light bulb. The digital display shows: INPUT AC 2.0 kW, OUTPUT 230 V.</p>

<p>Battery voltage and AC output voltage</p>	<p>Battery voltage = 24.0 Vdc, output voltage = 230 Vac</p>  <p>The diagram shows an MPPT (Maximum Power Point Tracking) module connected to a battery. The battery is connected to an AC/DC converter, which is connected to a load. The display shows the battery voltage as 24.0V and the AC output voltage as 230V.</p>
<p>AC output frequency</p>	<p>Output frequency = 50 Hz</p>  <p>The diagram shows an MPPT module connected to a battery. The battery is connected to an AC/DC converter, which is connected to a load. The display shows the battery voltage as 24.0V and the AC output frequency as 50.0 Hz.</p>
<p>AC output percentage of nominal inverter power</p>	<p>Load percent = 60%</p>  <p>The diagram shows an MPPT module connected to a battery. The battery is connected to an AC/DC converter, which is connected to a load. The display shows the battery voltage as 24.0V and the load percentage as 60%.</p>
<p>AC output in VA (apparent power)</p>	<p>When load power is lower than 1 kVA, apparent power is shown in VA (ex. 500 VA)</p>  <p>The diagram shows an MPPT module connected to a battery. The battery is connected to an AC/DC converter, which is connected to a load. The display shows the battery voltage as 24.0V and the apparent power as 500 VA.</p> <p>When load power is higher or equal to 1 kVA, apparent power is shown in kVA (ex. 2.50 kVA)</p>  <p>The diagram shows an MPPT module connected to a battery. The battery is connected to an AC/DC converter, which is connected to a load. The display shows the battery voltage as 24.0V and the apparent power as 2.50 kVA.</p>

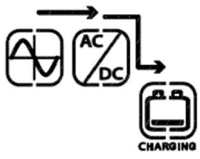
<p>Load in Watt (active power)</p>	<p>When load power is lower than 1 kW, active power is shown in W (ex. 500 W)</p>  <p>When load power is higher or equal to 1 kW, active power is shown in kW (ex. 2.50 kW)</p> 
<p>Battery voltage / DC discharging current</p>	<p>Battery voltage = 24 Vdc, discharging current = 1 Adc</p> 
<p>2 consecutive views are available:</p> <ul style="list-style-type: none"> • Main unit firmware version (U1) • Solar charge controller firmware version (U2) 	<p>U1 firmware version 20.14</p> 

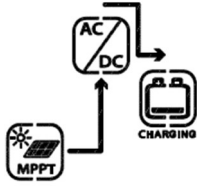
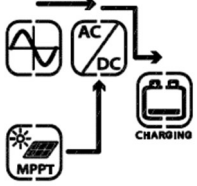
6.6 Operating Mode Description

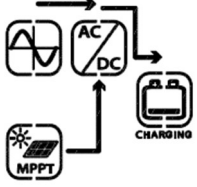
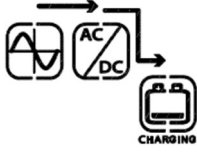
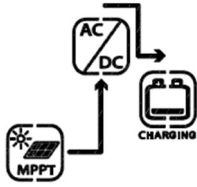
Operating mode	Behaviors	LCD display
<p>Stand-By mode</p> <p>The AC output is not turned on, but the unit can charge the battery without AC output (if the inverter ON/OFF switch is set to the OFF position).</p>	<p>No AC output voltage is supplied by the unit, but it still can charge batteries</p>	<p>Battery is charged by an AC source</p> 

		<p>Battery is charged by solar power</p> 
		<p>Battery is charged by AC source and solar power</p> 
		<p>No charging</p> 
<p>Fault mode Errors are currently active (see chapter "Fault Reference Codes" for details)</p>	<p>Solar power and AC source can charge batteries</p>	<p>Battery is charged by AC source and solar power</p> 
		<p>Battery is charged by an AC source</p> 
		<p>Battery is charged by solar power</p> 
		<p>No charging</p> 

Grid mode	AC output is fully powered from the AC input, battery charging is available	Battery is charged by AC source and solar, and AC loads are powered by AC source
		Solar power and AC source are charging the battery. AC loads are powered by AC source
Off-Grid mode	AC output power from battery and solar power	Battery and solar provide power to the AC output
		Only battery provides power to the AC output

7.0 Cleaning and Maintenance

The Any-Grid PSW-B requires very little maintenance. The following maintenance tasks should be performed in the defined intervals. Before performing any of the tasks in this chapter, ensure the unit is completely powered down. To do this turn OFF the AC output ON/OFF switch at the right side of the unit. Then switch open / disable the following breakers or remove the following fuses in this order:

1. AC output
2. PV input
3. AC input
4. Battery

After the maintenance procedures turn the unit on again in the reverse order (steps 4 to 1 above, followed by turning the AC output switch ON).

7.1 Every Month

The Any-Grid PSW-B is equipped with dust filters near the top of the unit to remove as much dust and debris from the air being taken into the device for cooling as possible. These particles are trapped in the removable and washable filters on the left and right side of the unit. Inspect and, if necessary, wash them as follows:

1. Loosen and remove the thumbscrew on each of the two sides by turning it counterclockwise.

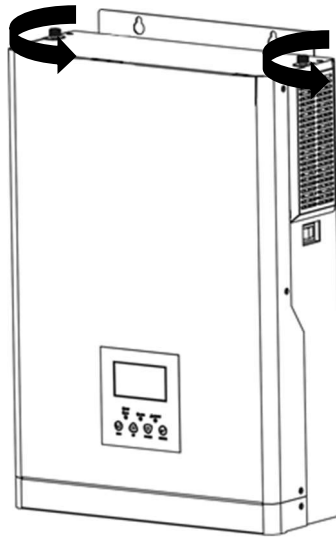

Fig. 18: Dust filter screw removal

2. Slightly push up and out the metal ventilation grilles from their retaining slots on both sides to expose the filter elements.

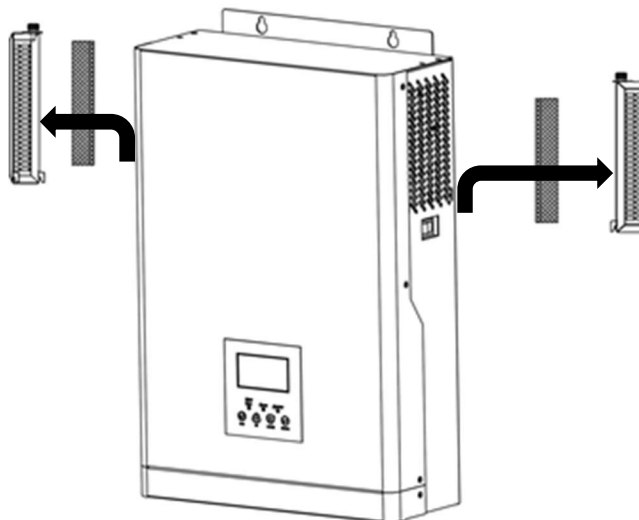

Fig. 19: Dust filter removal

3. If there is obvious dust and / or dirt on the filters, carefully wash them out under tap water. Then dab them dry with kitchen roll paper or a towel and ensure they are dry to the touch.
4. Re-install the filter by working in reverse to the removal process. Apply the dry and clean filter element to the unit's air opening and place the ventilation grille over it by sliding it downwards into the slots of the main unit. Fasten the thumbscrew in a clockwise direction and tighten it without applying excessive force or tools. Do the same on the other side.

If the unit is being used in a very low-dust clean environment and the first monthly inspection shows little to no dust in the filters, the filter maintenance may be done every 6 months instead of every month.









7.2 Every 6 Months







1. Clean the outside of the unit with a damp cloth. Do not use any solvents other than mild soap if necessary. Ensure the cloth used for cleaning is only damp and not dripping wet.
2. Ensure the AC input, AC output, PV and battery terminal screws are securely tightened to the torques mentioned in the chapter "**Installation**".
3. Inspect the unit and wiring for any burn marks or any other signs of problems. If any are present, have an electrician rectify them.

4. Turn the Any-Grid PSW-B on again as instructed in the beginning of this chapter. Once at least the battery and AC output are enabled, and the load switch is ON, do the following:



If using a residual current device (RCD) at the AC output (strongly recommended), unless instructed differently by the RCD manufacturer, press the “Test” button on it. This will induce a fault current to ground and the RCD must switch off immediately, cutting power to the loads. If it does not, replace the RCD and repeat this test.





8.0 Fault Reference Codes

Fault Code	Fault Event	Screen View
01	Fan is locked while inverter is off	01 
02	Over-temperature	02 
03	Battery voltage is too high	03 
04	Battery voltage is too low	04 
05	AC output is short circuited or internal over-temperature	05 
06	AC output voltage is too high	06 
07	AC output overload timeout	07 
08	Internal DC bus voltage is too high	08 
09	Internal DC bus soft start failed	09 

51	Internal inverter over-current	 51
52	Internal DC bus voltage is too low	 52
53	Inverter soft-start failed	 53
55	DC voltage component in AC output too high	 55
56	Battery disconnected	 56
57	Inverter current sensor failed	 57
58	Output voltage too low	 58

9.0 Warning Codes

Warning Code	Warning Event	Audible Alarm	Screen View
01	Fan is locked while inverter is on	Beeps three times every second	 01
03	Battery is over-charged	Beeps once every second	 03
04	Low battery voltage	Beeps once every second	 04

07	AC output overload	Beeps twice every second	  07
10	AC output power de-rating	Beeps twice every 3 seconds	 10
Eq	Battery equalization active	None	 Eq

10.0 Troubleshooting

Problem	LCD / LED / Buzzer	Explanation / Possible cause	What to do
Unit shuts down automatically during start-up process.	LCD / LEDs and buzzer will be active for 3 seconds and then turn off.	The battery voltage is too low (< 22.9 V)	1. Re-charge battery 2. Replace battery
No response after power on.	No indication.	1. The battery voltage is far too low (< 16.8 V) 2. Battery polarity is connected in reverse, causing internal fuse to blow	1. Check if batteries and the wiring are connected correctly, check battery polarity. 2. Re-charge battery. 3. Replace battery. 4. Return to repair center.
AC source exists but the unit works in Off-Grid mode.	Input voltage displayed as 0 on LCD, green LED flashing.	Input circuit breaker is tripped	Check if AC circuit breaker is tripped and AC wiring is connected correctly.
	Green LED is flashing.	Insufficient quality of AC power (Grid or Generator)	1. Check if AC wires are too thin and/or too long. 2. Check if generator (if applied) is working correctly or if input voltage range setting is correct (try switching from UPS mode → Appliances mode), see chapter "Device Operation Settings" → "Settings menu 03" for details.
	Green LED is flashing.	"Solar first" or "SBU" is set as the priority of the AC output source.	Change output source priority to "Utility / AC input first", see chapter "Device Operation Settings" → "Settings menu 01" for details.
When the unit is turned on, internal relay is switched on and off repeatedly.	LCD and LEDs are flashing	Battery is disconnected.	Check if battery wires are well connected.

Buzzer beeps continuously and red LED is on.	Fault code 07	Overload error. Inverter is overloaded $\geq 105\%$ for more than allowed duration.	Reduce the connected load by switching off some equipment.
	Fault code 05	Output short circuited.	Check if wiring is connected well and remove abnormal loads.
	Fault code 02	Temperature of inverter components is over 100°C.	Check whether the air flow of the unit is blocked or whether the ambient temperature is too high.
	Fault code 03	Battery is over-charged.	Return to repair center.
		The battery voltage is too high.	Check if specifications and quantity of batteries meet requirements.
	Fault code 01	Fan fault	Replace the fan(s)
	Fault code 06/58	AC output abnormal	1. Reduce the connected load. 2. Return to repair center
	Fault code 08/09/53/57	Internal components failed.	Return to repair center.
	Fault code 51	Over current or surge.	Restart the unit, if the error occurs again, please return to repair center.
	Fault code 52	Internal DC bus voltage too low.	
	Fault code 55	Output voltage unbalanced.	
Fault code 56	Battery not connected correctly / internal fuse blown.	If the battery is connected correctly, please return to repair center.	

11.0 Specifications

11.1 Grid Mode

Model	PSW-B-3KW-230/24V AC output set to 220, 230 or 240 Vac See chapter " Device Operation Settings " → " Settings menu 10 " for details.	PSW-B-3KW-230/24V AC output set to 110, 120 or 127 Vac See chapter " Device Operation Settings " → " Settings menu 10 " for details.
AC Input Voltage Waveform	Pure Sine Wave (utility or generator)	
Nominal AC Input Voltage	Programmable: 220/230 (Default)/240 Vac	Programmable: 110/120/127 Vac
Maximum AC Input Current	30 Aac	
AC Input Overvoltage Category	OVC III	
Low Loss AC Input Voltage	170 Vac \pm 7 Vac (UPS mode) 90 Vac \pm 7 Vac (Appliances mode) See chapter " Device Operation Settings " → " Settings menu 03 " for details.	90 Vac \pm 7 Vac (UPS mode) 80 Vac \pm 7 Vac (Appliances mode) See chapter " Device Operation Settings " → " Settings menu 03 " for details.
Low Loss Return AC Input Voltage	180 Vac \pm 7 Vac (UPS mode) 100 Vac \pm 7 Vac (Appliances mode)	100 Vac \pm 7 Vac (UPS mode) 90 Vac \pm 7 Vac (Appliances mode)
High Loss AC Input Voltage	280 Vac \pm 7 Vac	140 Vac \pm 7 Vac

High Loss Return AC Input Voltage	270 Vac \pm 7 Vac	135 Vac \pm 7 Vac
Maximum AC Input Voltage	300 Vac	150 Vac
Nominal AC Input Frequency	50 Hz / 60 Hz	
Low Loss Frequency	40 Hz \pm 1 Hz	
Low Loss Return AC Input Frequency	42 Hz \pm 1 Hz	
High Loss AC Input Frequency	65 Hz \pm 1 Hz	
High Loss Return AC Input Frequency	63 Hz \pm 1 Hz	
Output Short Circuit Protection	Grid mode: Circuit breaker (amperage equivalent to maximum AC input current, resettable) Off-Grid mode: Electronic protection	
Transfer Time between Grid mode and Off-Grid mode and vice versa	10 ms typical (UPS mode), 20 ms typical (Appliances mode) See chapter " Device Operation Settings " \rightarrow " Settings menu 03 " for details.	
AC Output Power De-Rating In Grid mode, the maximum AC output power is dependent on the AC input voltage.	Maximum AC output power formula when in Grid mode: 30 Aac x AC input voltage = Max. AC output power Example: 30 Aac x 230 Vac = 4,800 W	Maximum AC output power formula when in Grid mode: 30 Aac x AC input voltage = Max. AC output power Example: 30 Aac x 120 Vac = 3,600 W

11.2 Off-Grid Mode

Model	PSW-B-3KW-230/24V
Nominal AC Output Power	3000 VA / 3000 W if AC output is set to 220/230/240 Vac 1500 / 1637 / 1732 VA/W if AC output is set to 110/120/127 Vac, respectively
AC Output Voltage Waveform	Pure Sine Wave
AC Output Voltage Regulation	230 Vac \pm 5% default (programmable, 110 ~ 240 Vac \pm 5%)
Total Harmonic Distortion of Voltage	< 5% for linear load, < 10% for non-linear load at nominal voltage
AC Output Frequency	50 Hz default or 60 Hz (programmable)
Inverter Peak Efficiency (from battery)	> 93%
AC Output Overload Protection	100 milliseconds @ \geq 205% nominal AC output power 5 seconds @ \geq 150% nominal AC output power 10 seconds @ 110% ~ 150% nominal AC output power
AC Output Surge Capacity	2x nominal power for 5 seconds
Nominal Battery Input Voltage	24 Vdc
Min. Battery Voltage for Inverter Start-up	23.0 Vdc default 1.0 Vdc. above "Low voltage disconnect" setting See chapter " Device Operation Settings " \rightarrow " Settings menu 29 " for details.

Low Battery Warning Voltage (relative to nominal AC output power) load < 20% 20% ≤ load < 50% load ≥ 50%	23.0 Vdc 21.4 Vdc 21.2 Vdc
Low Battery Warning Return Voltage (relative to nominal AC output power) load < 20% 20% ≤ load < 50% load ≥ 50%	24.0 Vdc 22.4 Vdc 21.2 Vdc
Low Battery Voltage Disconnect (relative to nominal AC output power) load < 20% 20% ≤ load < 50% load ≥ 50%	Programmable, see chapter “Device Operation Settings” → “Settings menu 29” for details. 22.0 Vdc 20.4 Vdc 19.2 Vdc
High Battery Disconnect Voltage	33 Vdc
High Battery Return Voltage	32 Vdc
DC Voltage Accuracy	± 0.3%V at no load
DC Offset	≤ 100 mV
AC Output Power De-Rating If the AC output load power is higher than the power in the diagram to the right, the AC output voltage will be decreased until the AC output power reaches the de-rated power specified to conserve battery. The lower limit of the AC output voltage de-rating is 95 and 190 Vac for 110/120/127 Vac and 220/230/240 Vac settings (see chapter “Device Operation Settings” → “Settings menu 10”), respectively.	<p>The graph shows AC Output Power on the vertical axis and Battery voltage on the horizontal axis. The power is constant at 80% nominal power until the battery voltage reaches 20.5 Vdc. Between 20.5 Vdc and 24 Vdc, the power increases linearly to reach 100% nominal power. For battery voltages above 24 Vdc, the power remains constant at 100% nominal power.</p>

11.3 Battery Charging

Charging from AC Source		PSW-B-3KW-230/24V
Model	PSW-B-3KW-230/24V	
Max. Battery Charging Current at Nominal AC Input Voltage	60 Adc	
Boost Charging Voltage	Flooded Battery	29.2 Vdc
	AGM / Gel Battery	28.8 Vdc
Floating Charging Voltage	27.6 Vdc	

Overcharge Protection	33 Vdc
Charging Algorithm	4-Stage with Equalization
<p>Charging Curve</p> <p>If battery type "User-defined" is set in chapter "Device Operation Settings" → "Settings menu 05", the charging parameters are set with the following settings menus:</p> <p>Charge current limit: 11 Boost voltage: 26 Boost duration: 32 Float voltage: 27 Equalization: 33, 34, 35, 36, 37</p>	
Charging from MPPT Solar Charge Controller	
Model	PSW-B-3KW-230/24V
Max. Usable Solar Power	1800 W
Max. Solar Array Power	2250 Wp
Max. Solar Array Open Circuit Voltage, Overvoltage Category	145 Vdc, OVC II
Solar Array MPP Voltage Range	30 ~ 115 Vdc
Max. Usable Solar Input Current	60 Adc
MPPT Start-Up Voltage	Battery voltage + 5 Vdc

11.4 General

Model	PSW-B-3KW-230/24V
Certifications	CE, RoHS, produced in ISO 9001 & ISO 14001 certified facility
Idle Self-Consumption	< 22 W
Operating Temperature Range	-10 ~ 50 °C, 14 ~ 122 °F
Storage Temperature	-15 ~ 60 °C, 5 ~ 140 °F
Humidity	5% to 95% Relative Humidity (non-condensing)
Ingress Protection, Pollution Degree	IP21, pollution degree 2, for indoor use
Housing Dimensions (H x W x D)	464 x 314 x 119 mm 18.3 x 12.4 x 4.7 in
Net Weight	9.6 kg / 21.2 lbs

12.0 Warranty

12.1 Conditions

We warranty this product against defects in materials and workmanship for a period of 24 months from the date of purchase and will repair or replace any defective unit when directly returned, postage paid, to Phocos. This warranty will be considered void if the unit has suffered any obvious physical damage or alteration either internally or externally. This warranty does not cover damage arising from improper use, such as plugging the unit into unsuitable power sources, attempting to operate products that require excessive power consumption, or use in unsuitable environments. This is the only warranty the company makes. No other warranties express or implied including warranties of merchantability and fitness for a particular purpose. Repair and replacement are your sole remedies and the company shall not be liable for damages, whether direct, incidental, and special or consequential, even if caused by negligence.

Further details about our warranty conditions can be found at www.phocos.com.

12.2 Liability Exclusion

The manufacturer shall not be liable for damages, especially on the battery, caused by use other than as intended or as mentioned in this manual or if the recommendations of the battery manufacturer are neglected. The manufacturer shall not be liable if there has been service or repair carried out by any unauthorized person, unusual use, wrong installation, or incorrect system design.

Specifications are subject to change without notice.

Copyright © 2020 Phocos AG, All Rights Reserved.

Version: 20200715

Made in China

Phocos AG
Magirus-Deutz-Str. 12
89077 Ulm, Germany

Phone +49 731 9380688-0

Fax +49 731 9380688-50

www.phocos.com

info@phocos.com

